

NOTICE MONTAGE

FILETS CÂBLE

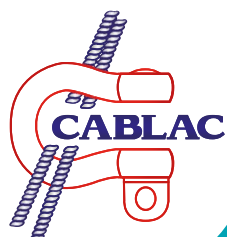
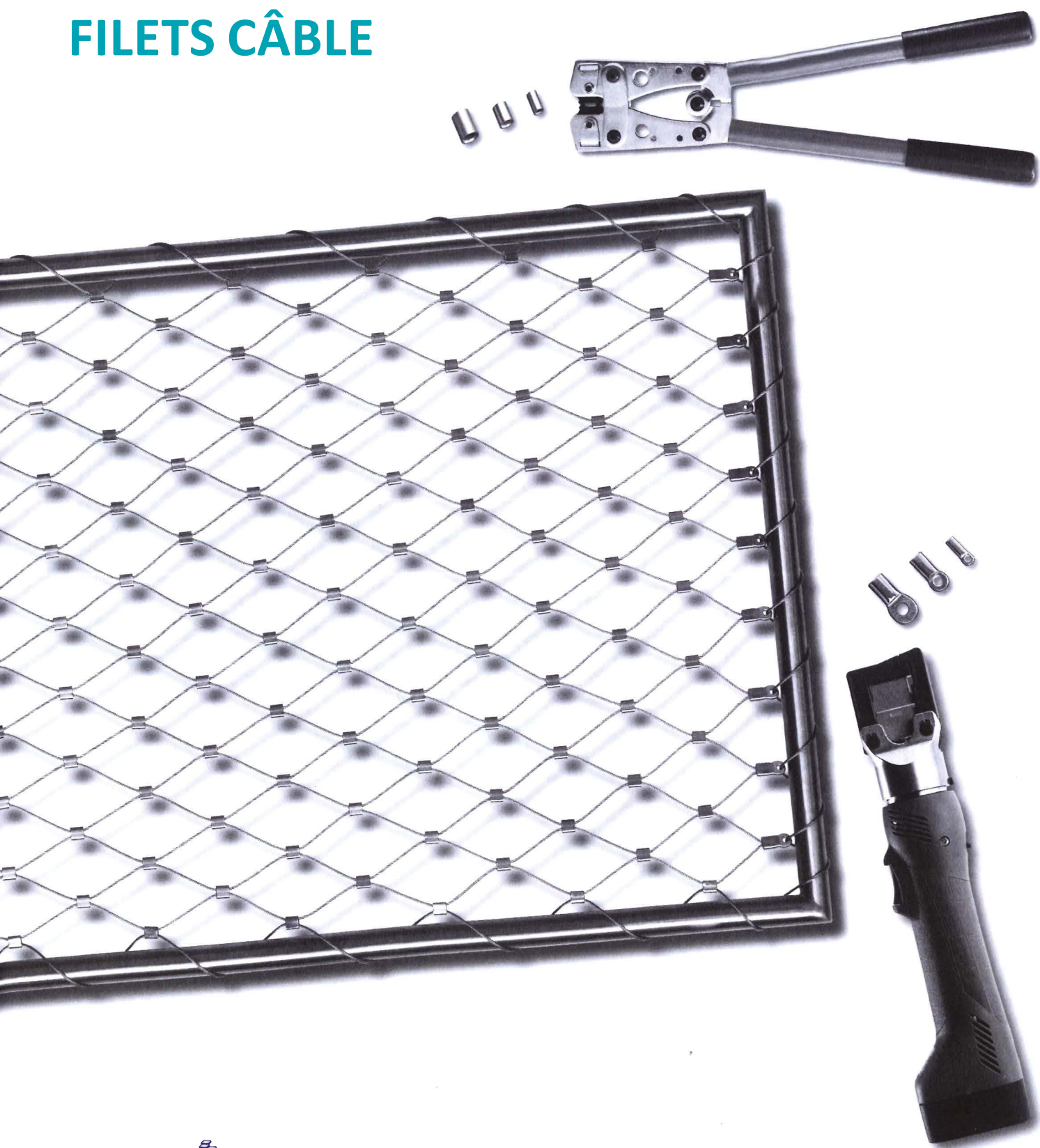

14 ZONE ARTISANALE - 25320 GRANDFONTAINE
Tél. : 03 81 58 46 00 - Fax : 03 81 58 46 01
E-mail : commercial@cablac.fr - www.cablac.fr

NOTICE MONTAGE

MONTAGE PAR UTILISATEUR SUR SITE

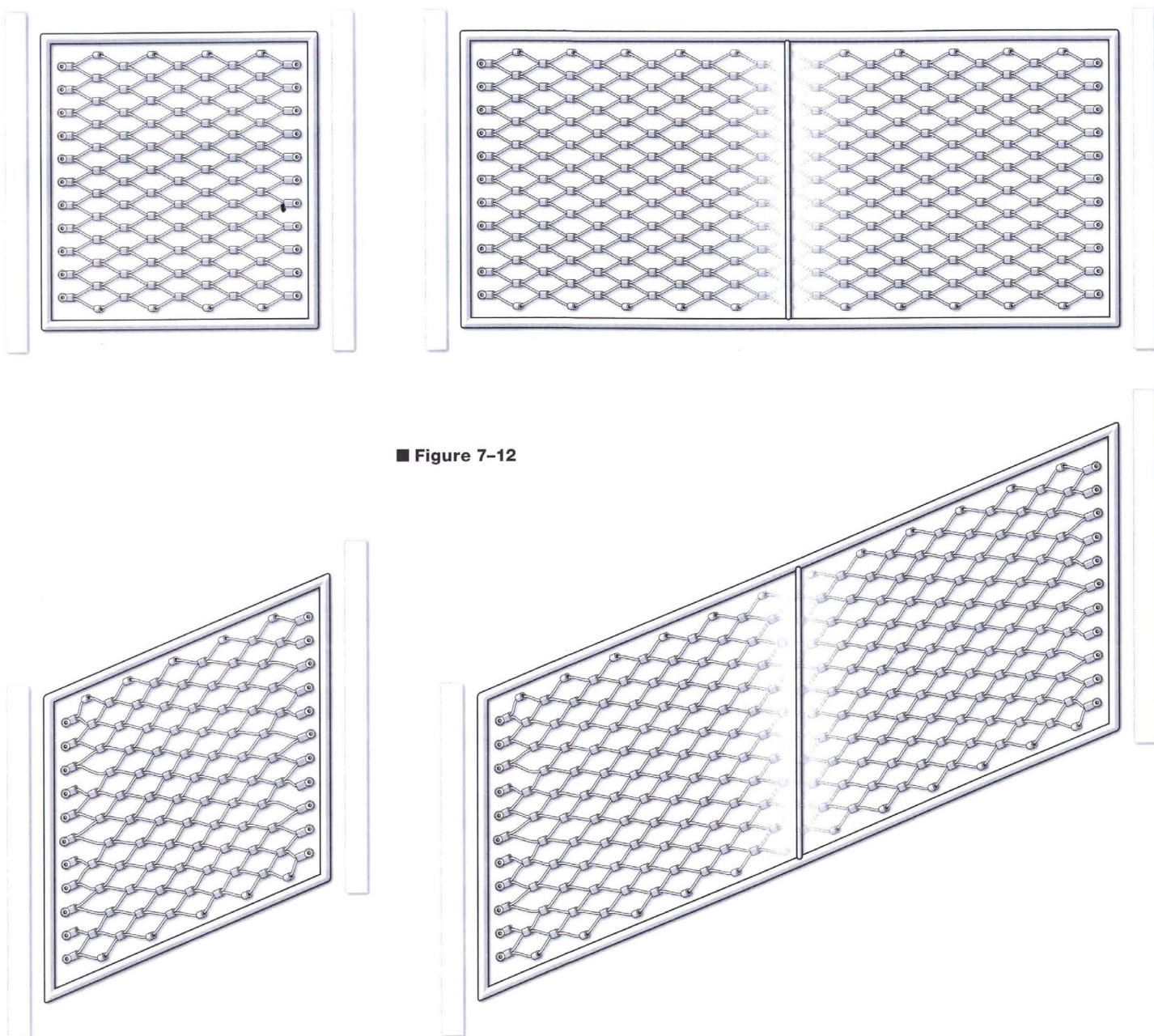

■ Figure 7-12

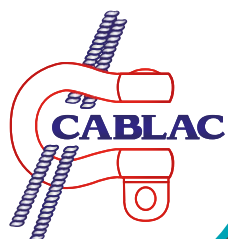

14 ZONE ARTISANALE - 25320 GRANDFONTAINE
Tél. : 03 81 58 46 00 - Fax : 03 81 58 46 01
E-mail : commercial@cablac.fr - www.cablac.fr

DIFFÉRENTS TYPES DE PINCES

■ Pince type 1 (250 mm)

A  Ø 1/1,5 mm



Ø 1/1,5 mm

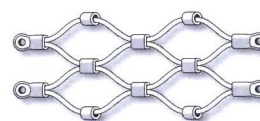

■ Pince type 1 (300 mm)

B  Ø 1/1,5/2 mm



Ø 1/1,5/2 mm

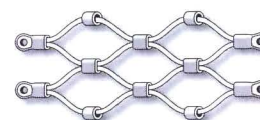

■ Pince type 2 (400 mm)

C  Ø 1/1,5/2/3 mm

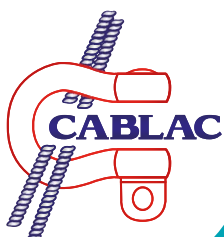
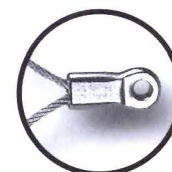
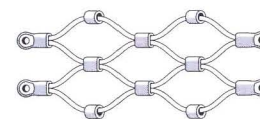
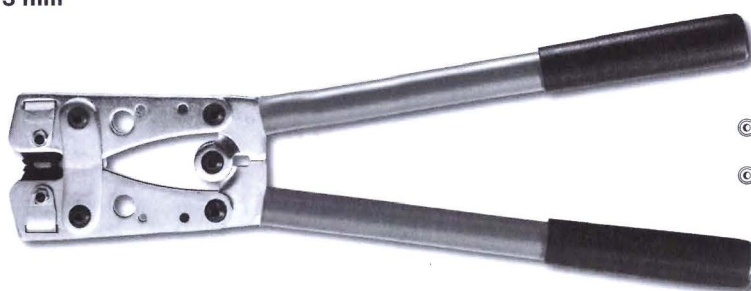

NOTICE MONTAGE

DIFFÉRENTS TYPES DE SERTISSEUSES

■ Sertisseuse à accu

Conforme à l'autorisation DIBt Z-14.7-557

D  Ø 1/1,5/2/3/4 mm



Werkzeugmarkierung:
Marquage outil:
Insert marking:
Seil / Câble / Rope Ø

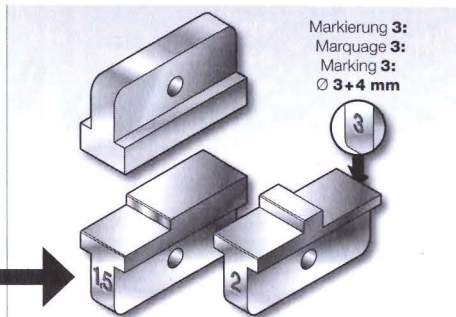

Markierung 3:
Marquage 3:
Marking 3:
Ø 3+4 mm

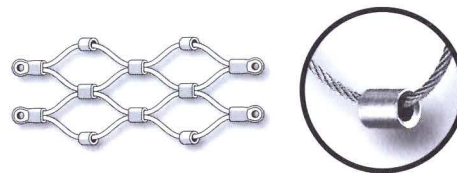

Ø 1/1,5/2/3/4 mm

Seil Câble Rope	Werkzeugmarkierung Marquage outil Insert marking
Ø mm	Nr./N°/No.
1	1-4 30570-0005-10
1,5	
2	
3	
4	

■ Sertisseuse à accu

Conforme à l'autorisation DIBt Z-14.7-557

E  Ø 1/1,5 mm



Werkzeugmarkierung:
Marquage outil:
Insert marking:
Seil / Câble / Rope Ø

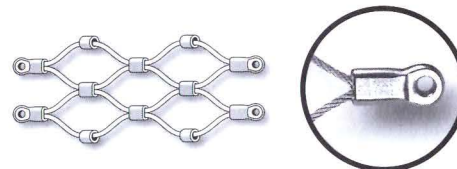
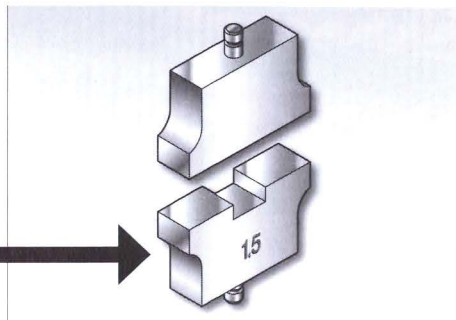

Ø 1/1,5 mm

Seil Câble Rope	Werkzeugmarkierung Marquage outil Insert marking
Ø mm	Nr./N°/No.
1	1
1	30570-0004-10
1,5	1,5
1,5	30570-0004-15

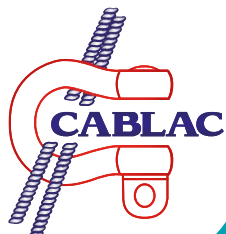

NOTICE MONTAGE

AUTRES OUTILS

■ Sertisseuse à accu EK 22 Conforme à l'autorisation DIBt Z-14.7-557

F  Ø 1/1,5/2/3 mm



Werkzeugmarkierung:
Marquage outil:
Insert marking:
Seil / Câble / Rope Ø

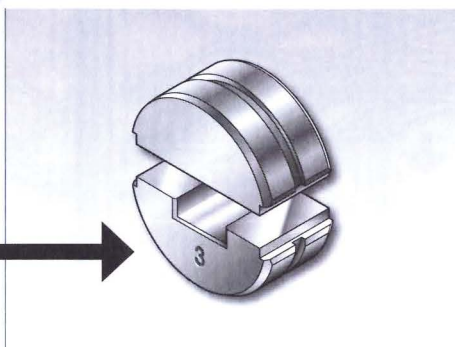

Ø 1/1,5/2/3 mm

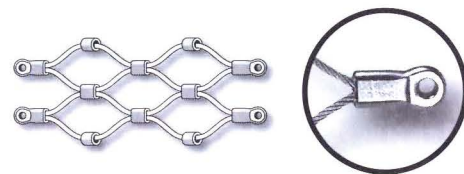

Seil Câble Rope	Werkzeugmarkierung Marquage outil Insert marking
Ø mm	Nr. / N° / No.
1	1
1	30570-0003-10
1,5	1.5
1,5	30570-0003-15
2	2
2	30570-0003-20
3	3
3	30570-0003-30

■ Pince coupe-câble

G  Ø max. 4 mm

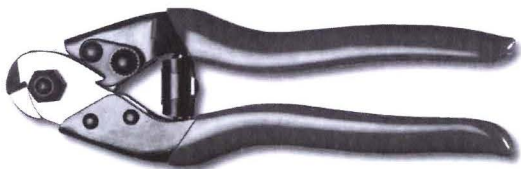

■ Attaches-câbles



Länge Longueur Length
mm
120
160
270
330

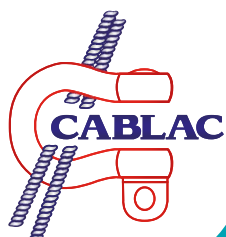

MONTAGE DE FILETS DANS CADRE TUBULAIRE À ANGLES DROITS

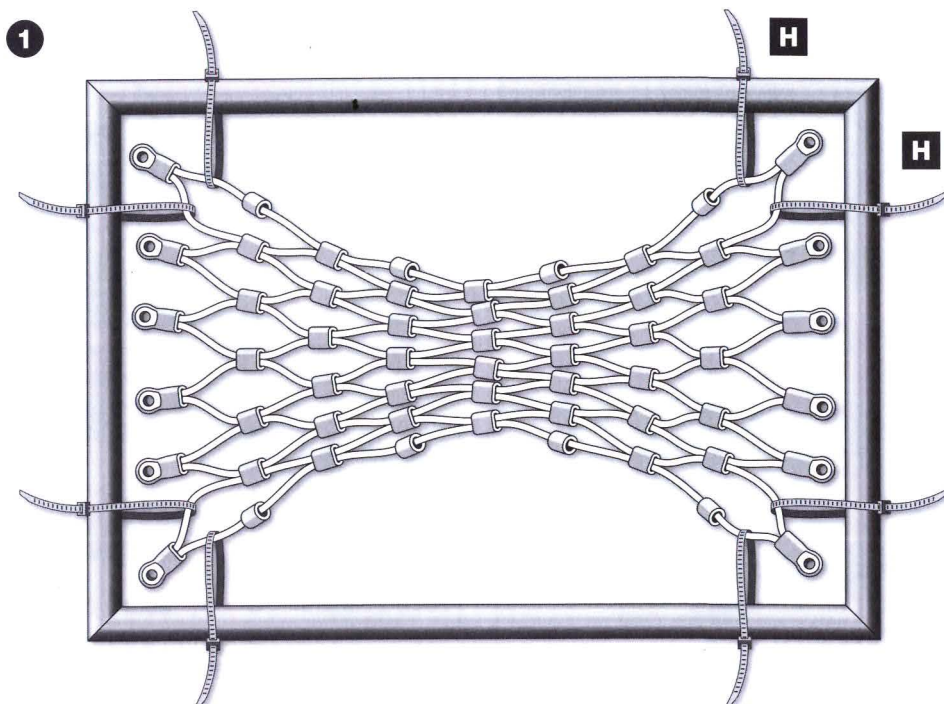

■ Au moyen d'attaches-câbles **H** centrer le **filet** aux **quatre coins** et le fixer.

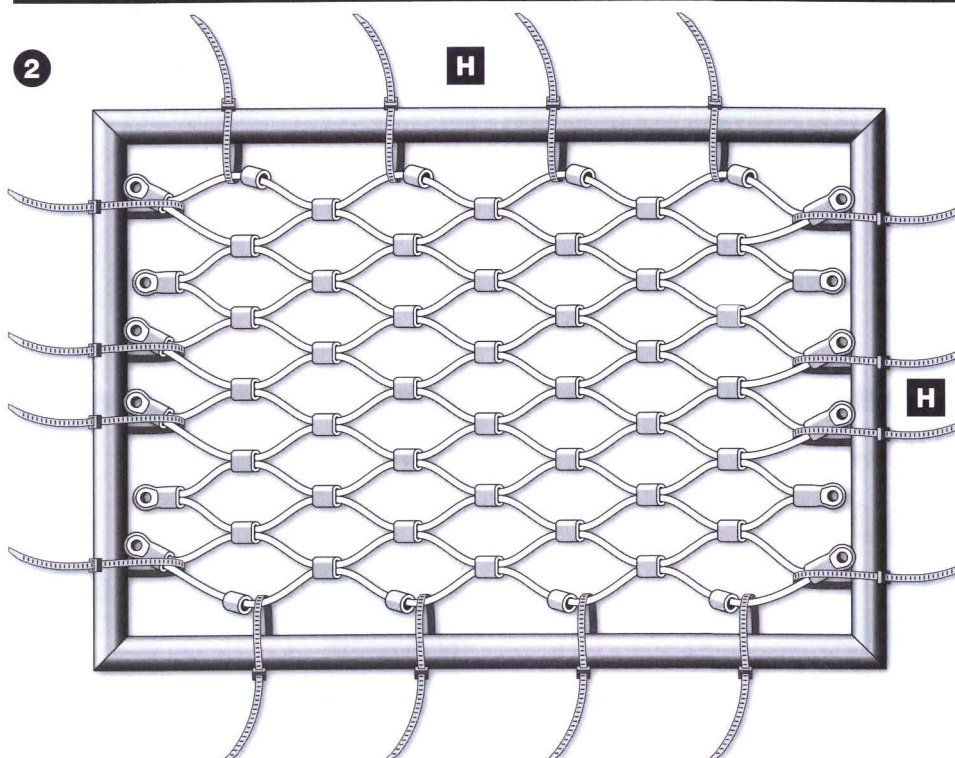

■ Au moyen d'attaches-câbles **H** centrer le **filet** aux quatre coins et le **fixer**.

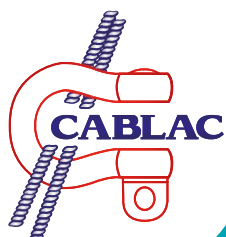

MONTAGE DE FILETS DANS CADRE TUBULAIRE À ANGLES DROITS

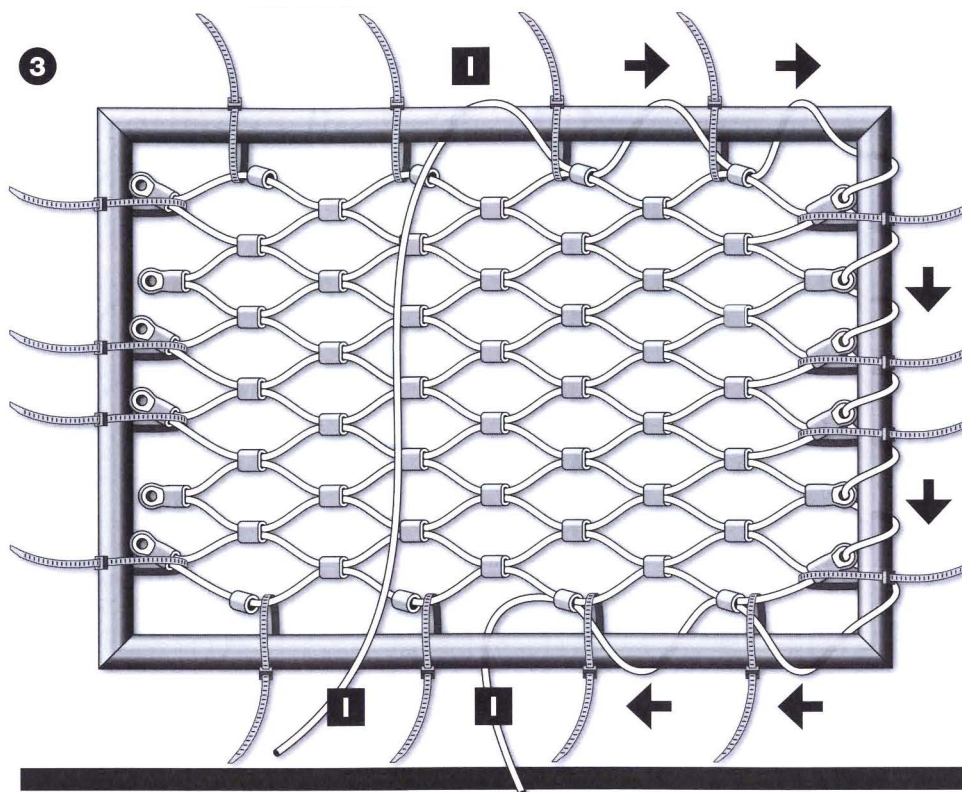

■ Sur un des côtés faire descendre le **câble périphérique I** du **centre supérieur** jusqu'au **centre inférieur**, en passant dans les douilles flottantes et œillets resp. autour du cadre tubulaire. Attention à respecter l'entrelacement.

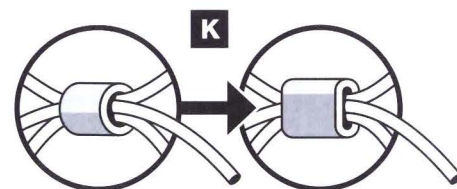
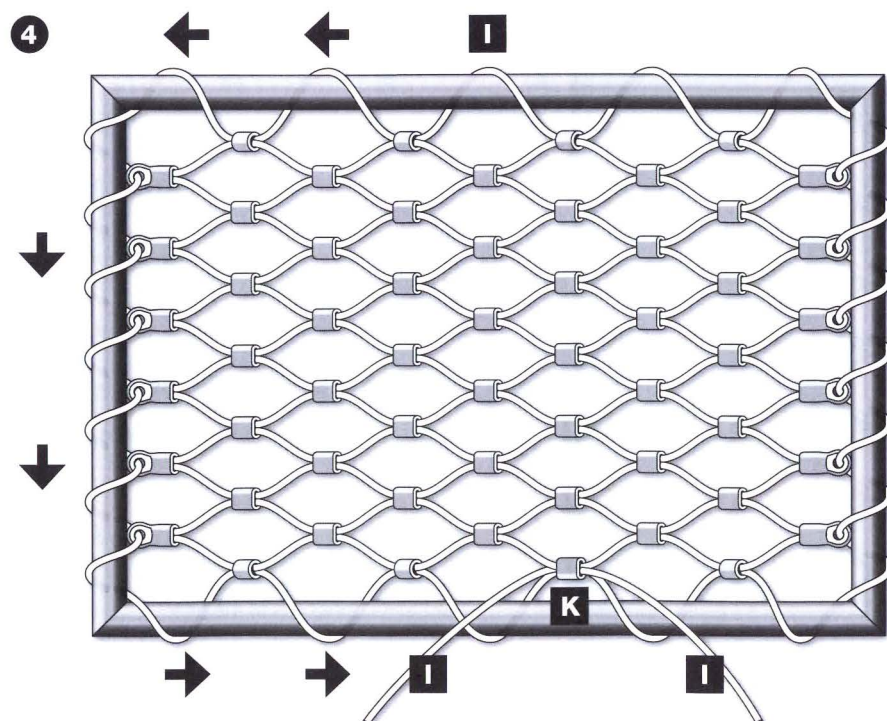

■ Sur l'autre côté faire passer le câble périphérique **I** selon description **3**, les deux extrémités du câble doivent être enfilées dans la **dernière douille flottante K**, puis tendues. Sertir la douille flottante **K** et ôter tous les attaches-câbles.

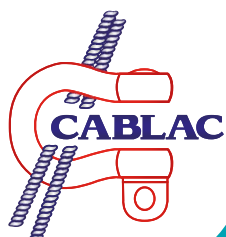

MONTAGE DE FILETS DANS CADRE TUBULAIRE À ANGLES DROITS

5

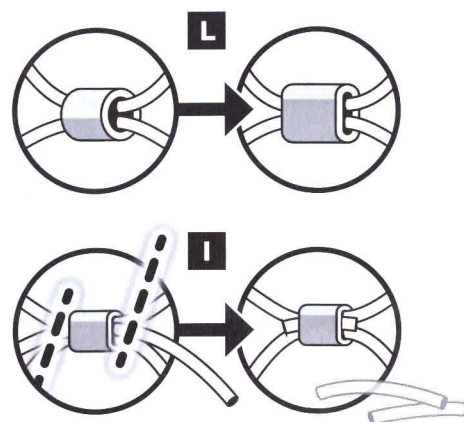
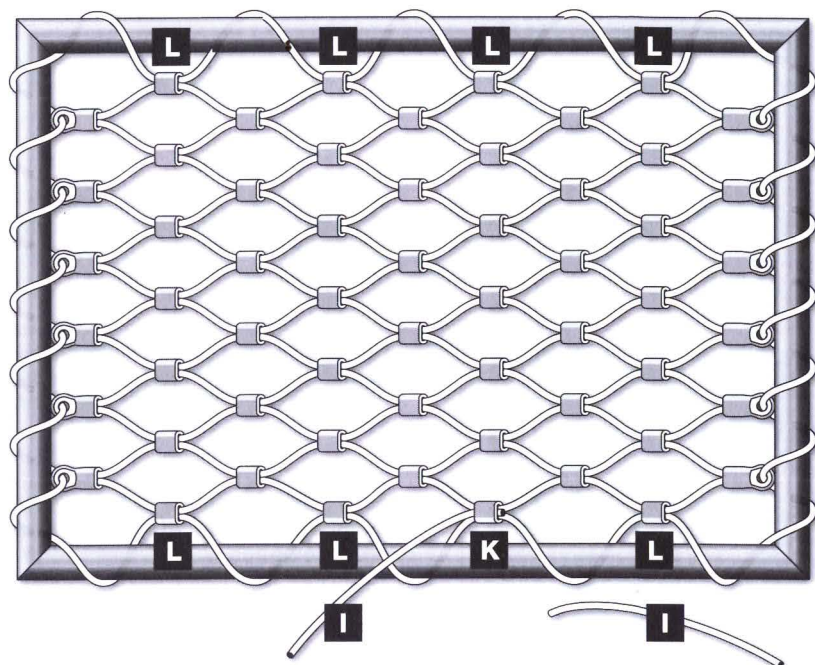

■ Sertir les douilles flottantes L au moyen de d'une pince ou d'une sertisseuse et couper les bouts du câble I.

6

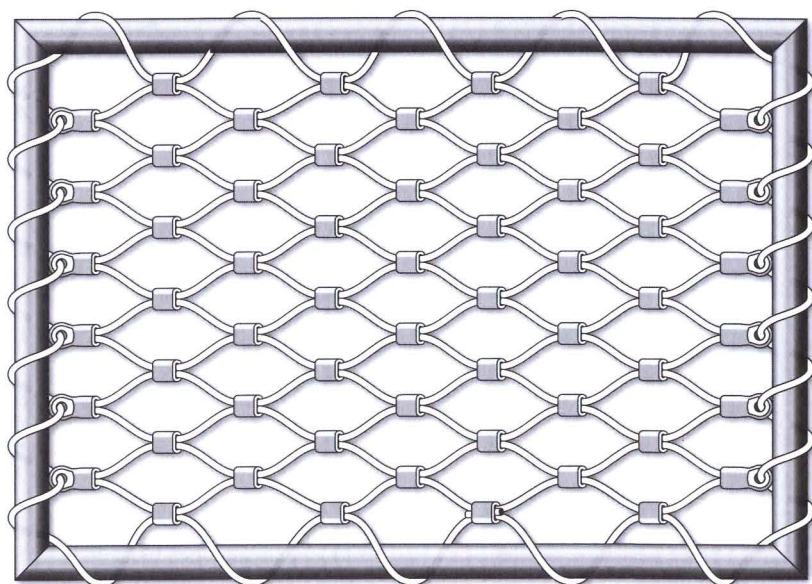

■ L'utilisateur doit vérifier de sa propre responsabilité **le sertissage sur place** et le diamètre correct du câble ou du toron par rapport aux douilles et œillets

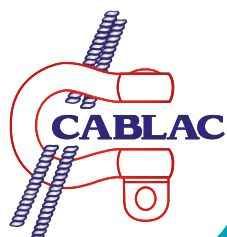

MONTAGE DE FILETS DANS CADRE TUBULAIRE À ANGLES OBLIQUES

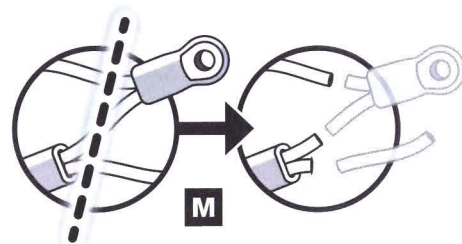
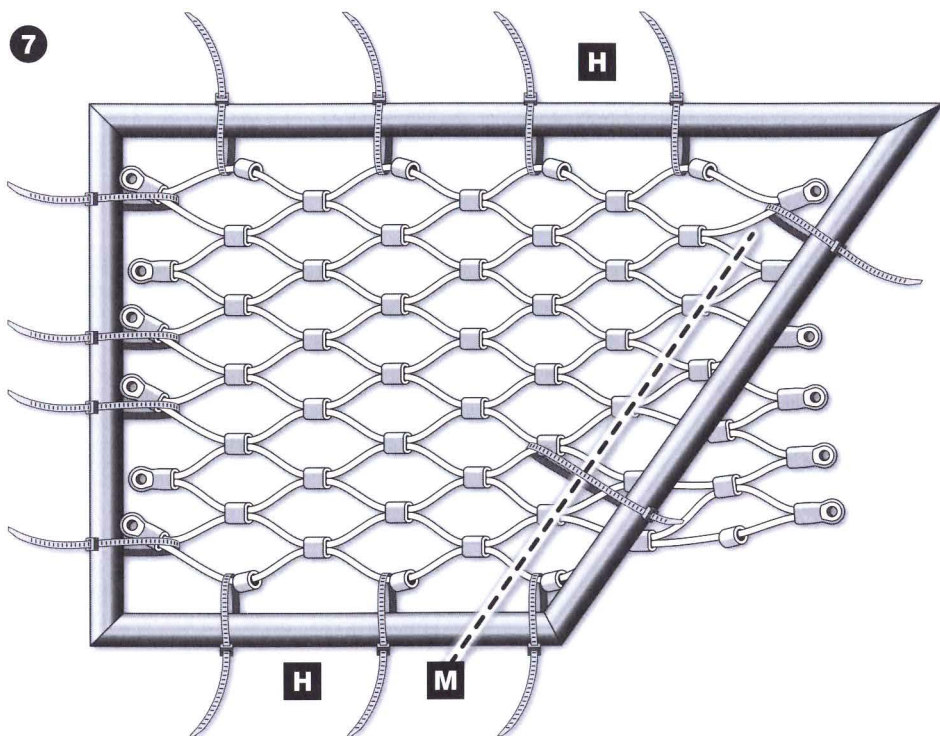

■ Au moyen d'attaches-câbles **H** centrer le **filet** et le **tendre**. Sur le côté incliné **marquer** tous les points de sectionnement **M** parallèles au bord en tube et les **couper**. Au besoin, **retirer** les douilles Webnet aux **points de sectionnement**.

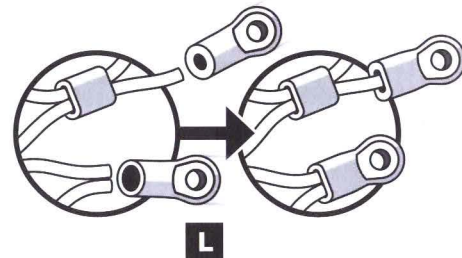
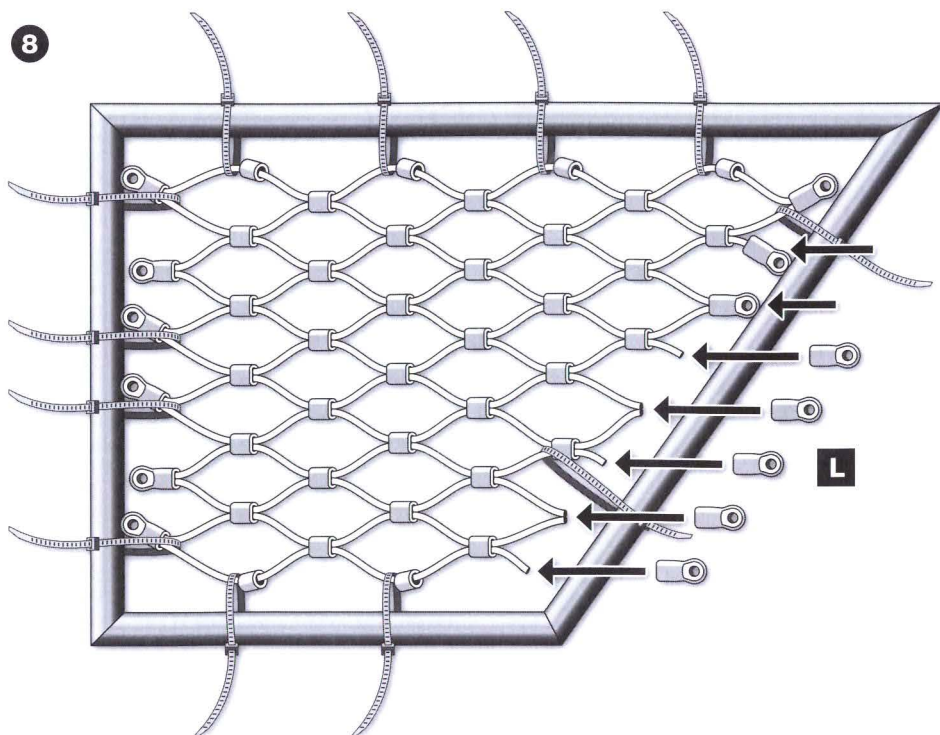

■ Sertir les **œillet**s sur les **extrémités de câble L** ouvertes au moyen de **pince** ou **sertisseuse**. Attention à choisir le modèle d'œillet qui convient pour un **ou deux câbles**!

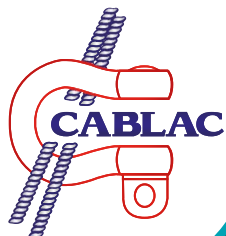

MONTAGE DE FILETS DANS CADRE TUBULAIRE À ANGLES OBLIQUES

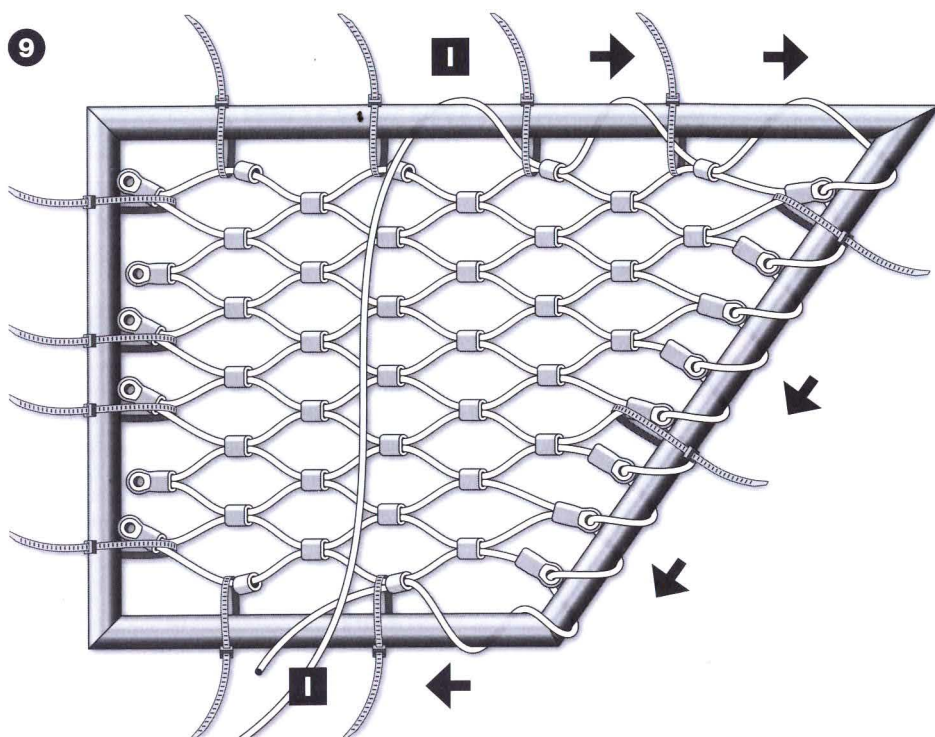

■ Sur un des côtés faire descendre le **câble périphérique I** du **centre supérieur jusqu'au centre inférieur**, en passant dans les douilles flottantes et œillets resp. autour du cadre tubulaire.
Attention à respecter l'entrelacement.

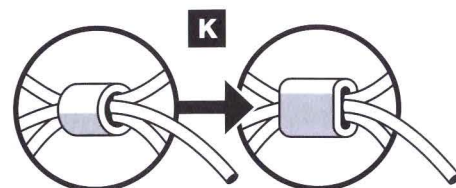
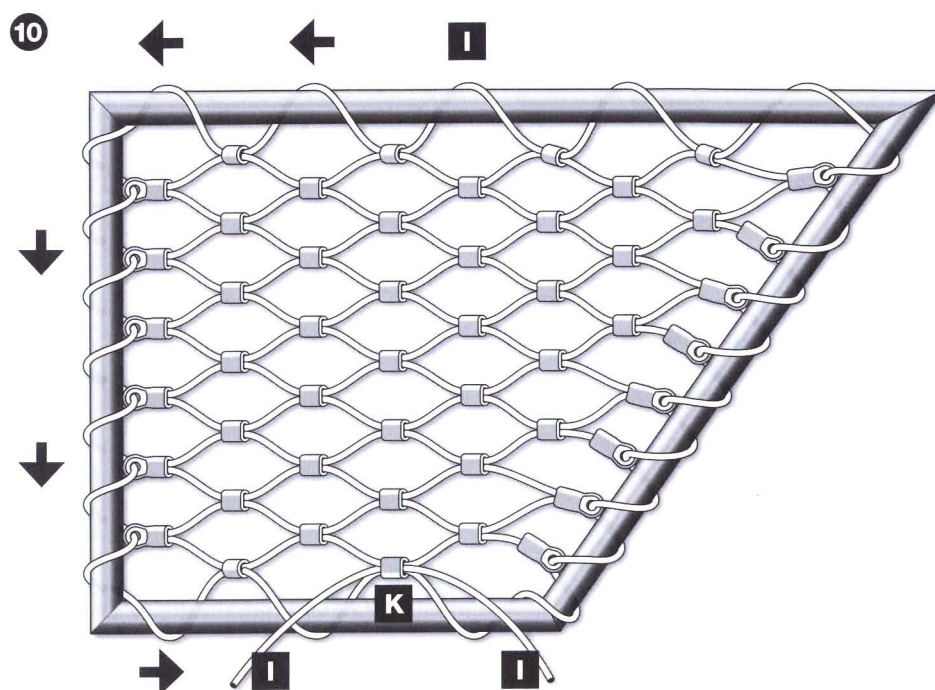

■ Sur l'autre côté faire passer le câble périphérique **I** selon description **9**, les deux extrémités du câble doivent être enfilées dans la **dernière douille flottante K**, puis tendues. **Sertir** la douille flottante **K** au moyen de l'**outil** et ôter tous les attaches-câbles.



MONTAGE DE FILETS DANS CADRE TUBULAIRE À ANGLES OBLIQUES

11

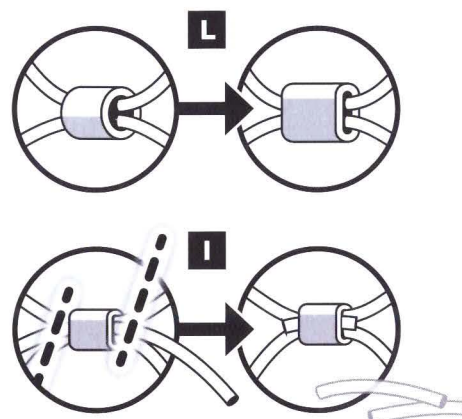
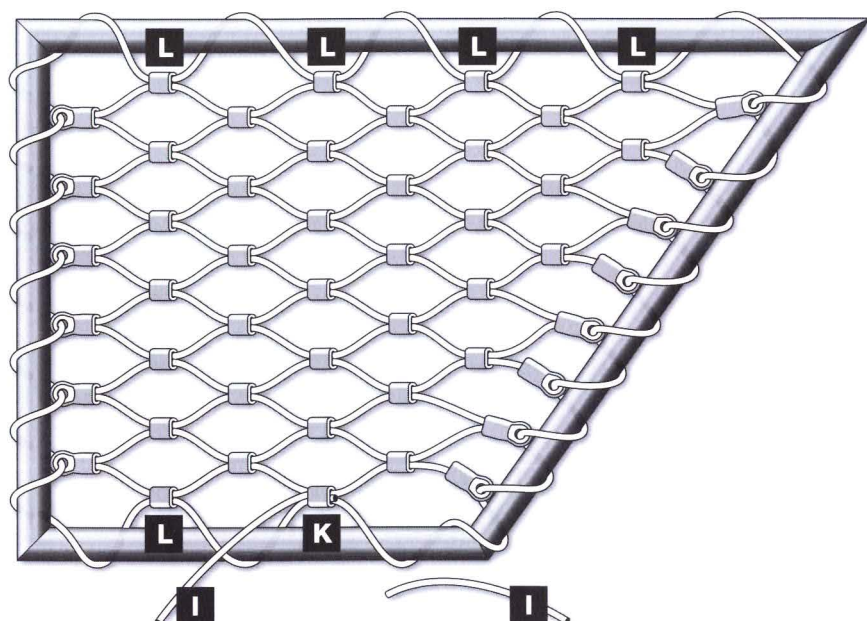

■ Sertir les douilles flottantes L
couper les bouts du câble I

12

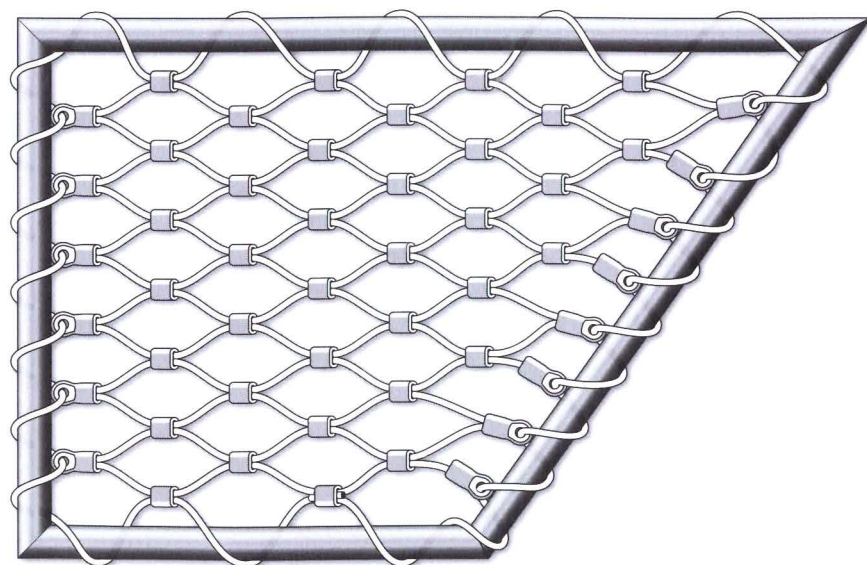

■ L'utilisateur doit vérifier de sa propre responsabilité **le sertissage sur place** et le diamètre correct du câble ou du toron par rapport aux douilles et œillets

